

SECTION B-B

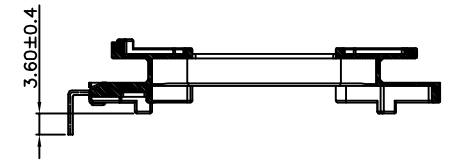

SECTION A-A

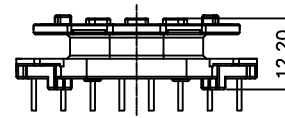
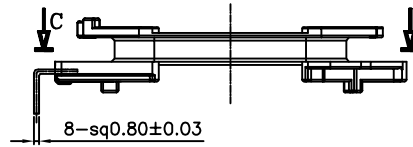
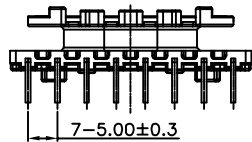
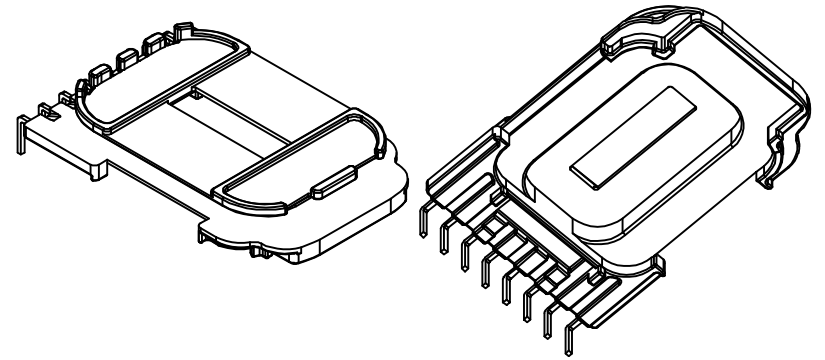
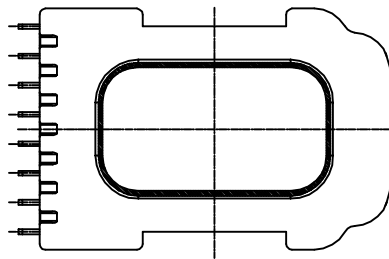

SECTION C-C

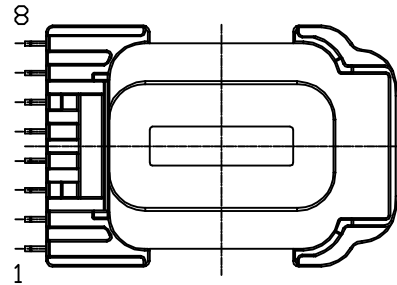

△							
△							
△							
△							
MARK	REVISION NOTE			DATE	DRAWN	CHECKED	APPROVED
DRAWN	CHECKED	APPROVED	MATERIAL : PET	UL REC. : UL94V-0	THIRD ANGLE PROJ.	SCALE : 1/1	
S H, Kim	D B, Han	C, Park	Z : PIN LENGTH (According to customer's request)	DATE : 2012.10.16	TOLERANCE : ±0.2 (Unless otherwise specified)	UNIT : m/m	
주식회사 대흥보빈 DAE HEUNG BOBBIN CO., LTD			TITLE EE 42*13 "V" (8P)		DWG NO DH-121107-3077-05		